



# TireGard™

13-315

Wireless Tire Pressure Monitoring System

User Guide



a product of  
**BIG BIKE PARTS®**



PN# 13-315

TireGard™

Wireless Tire Pressure Monitoring System

### **Table of Contents**

<b>Precautions</b>	2
TireGard™ Features and Benefits	2
<b>Controls</b>	3
LCD Receiver/Monitor Icon Descriptions	4
1. System Map	4
2. Setup of LCD Receiver/Monitor	5
3. Installation of the Front and Rear Sensors	6
<i>Anti –Theft Ring for Sensors (installation is optional)</i>	8
<b>Operation Instructions</b>	9
1. LCD Receiver/Monitor Basic Functions	9
2. Advanced Setting Mode	9
Operating Procedures	12
Battery Information	12
<b>Definition of Warnings</b>	13
Troubleshooting	13
Package Contents	14
Product Specifications	15
Warranty	15

## PRECAUTIONS

1. Please verify clearance when used with a 90 degree valve stem (Softail, etc.) to clear any and all calipers or other components before use.
2. Make sure the LCD receiver/monitor can receive signals from both the front and rear tire pressure sensors.
3. TireGard™ WTPMS has a unique anti-theft device to prevent the sensors from being stolen.
4. Please confirm that both sensors are fitted tightly. If necessary, spread detergent water on the valve stem to check for any air leakage. **DO NOT OVER TIGHTEN SENSORS.**
5. If tire pressure is low or dropping quickly, stop the motorcycle immediately and determine the problem.
6. The monitor will automatically make a connection with the sensors. It is normal that tire pressure figures might not be updated immediately due to changes of tire pressure.
7. TireGard™ WTPMS is designed to avoid interfering or being interfered with by other signals.
8. Many environmental factors can cause tire temperature to rise or fall. For example, hot weather or a warm tire will result in rising tire pressures.
9. The LCD Receiver/Monitor is **NOT** waterproof. If the LCD Receiver/Monitor accidentally gets wet, do not 'power on' the system until it is completely dried.

## TireGard™ FEATURES and BENEFITS

The TireGard™ Wireless Tire Pressure Monitoring System (WTPMS) is a powerful and effective tool for maximizing safety, increasing fuel economy, improving vehicle handling, and reducing operating cost. Through its wireless technology, tire pressure and temperature information is displayed instantly on the easy to read Graphic User Interface (LCD Receiver/Monitor) in real time.

- Do It Yourself (D.I.Y.) installation is quick and easy without any technical knowledge or special equipment.
- Wireless technology allows the sensor and monitor to connect automatically.
- Real-time highly accurate sensor and monitor with powerful Graphical User Interface.
- Fully adjustable pressure and temperature warning range with vibration and/or audible tone which immediately alerts operator through the LCD Monitor of abnormal tire pressure or temperature.
- Tire pressure and tire temperature data will update every time the sensor on tire experiences a 1 PSI pressure change.
- Anti-Theft Ring to prevent removal of sensor.
- Both Sensor and Monitor are battery powered with a low battery indicator on the LCD monitor which will instantly alert rider of battery power status.

## CONTROLS

### LCD Receiver/Monitor Controls Description

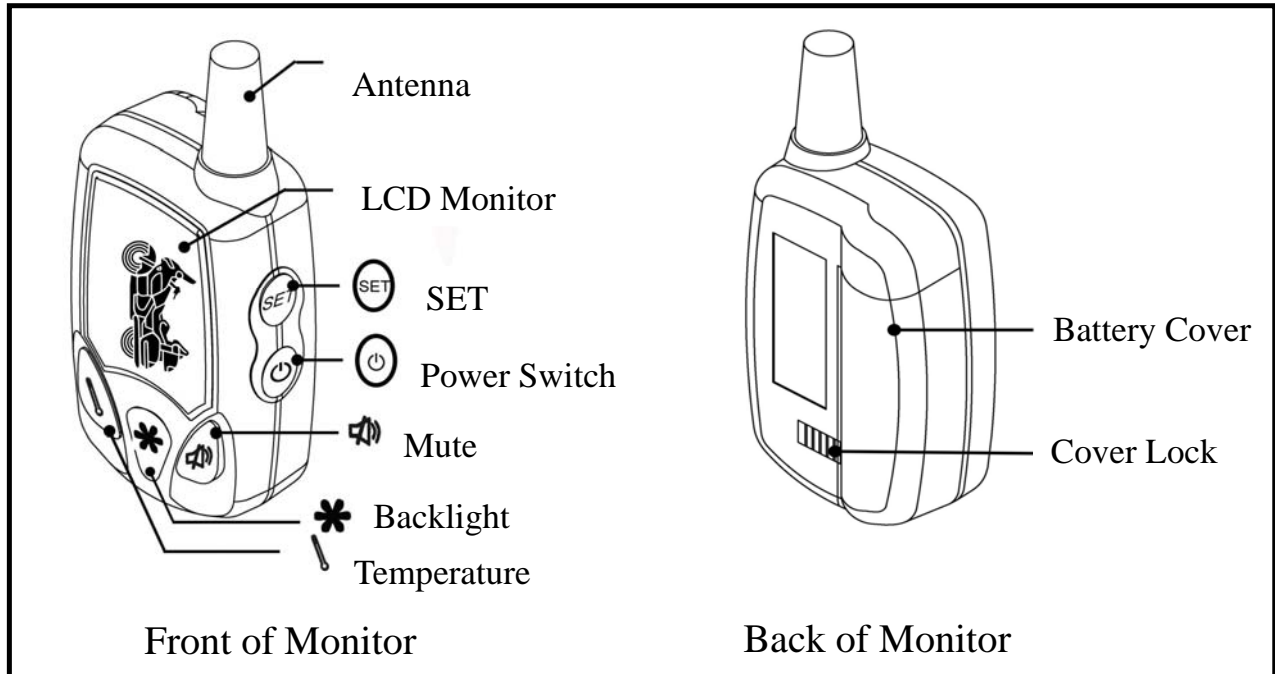

### Sensor Description

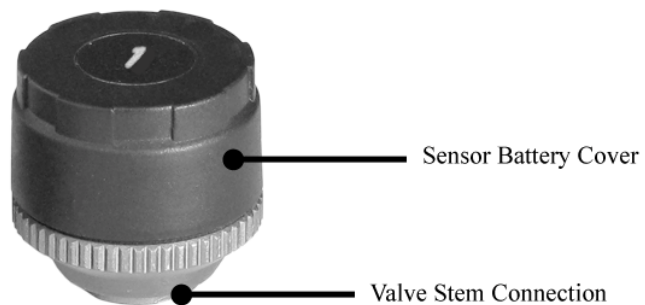

# LCD RECEIVER/MONITOR ICON DESCRIPTIONS

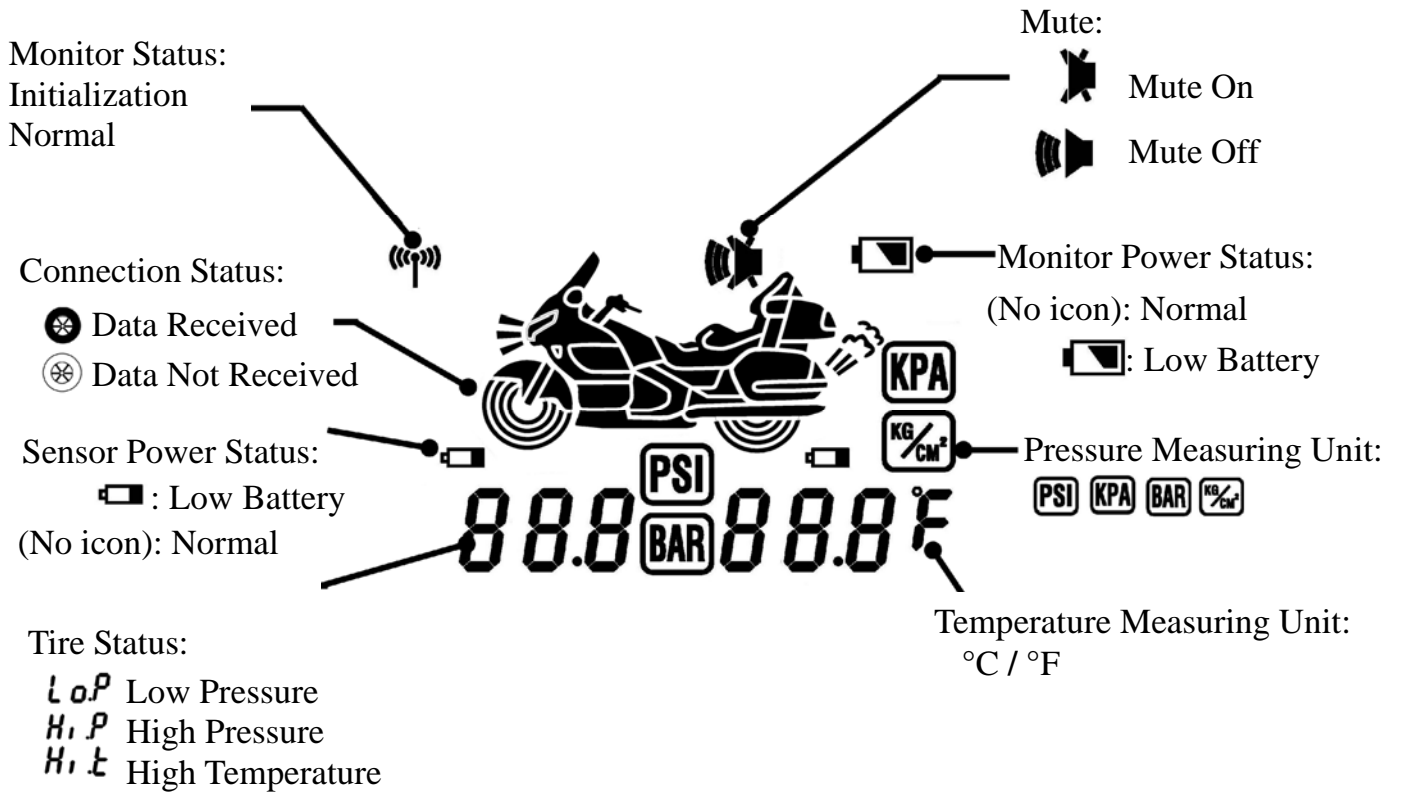

## 1. System Map

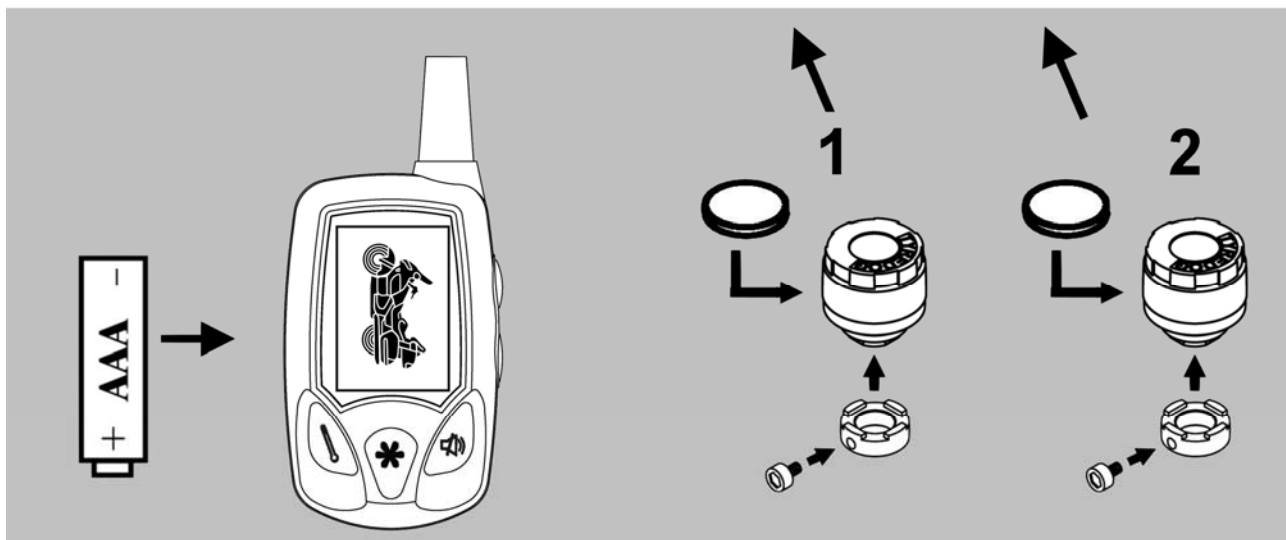

## 1. Setup of LCD Receiver/Monitor

Insert Battery:

- A. One AAA battery is required.
- B. To remove battery cover, follow the directions A and B on the picture shown below.

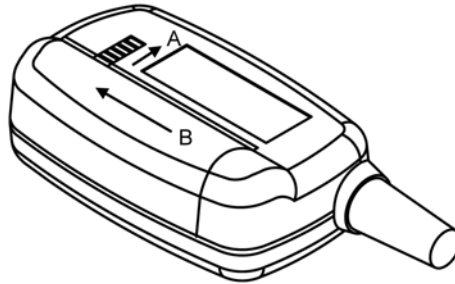

- C. Insert AAA battery properly.

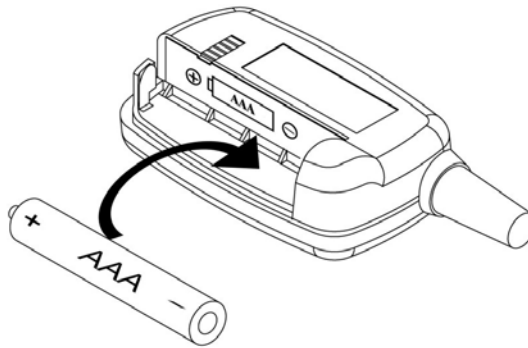

- D. After battery is inserted, the LCD Receiver/Monitor will issue a beep as it automatically powers up.
- E. Reinstall the battery cover onto LCD Receiver/Monitor.

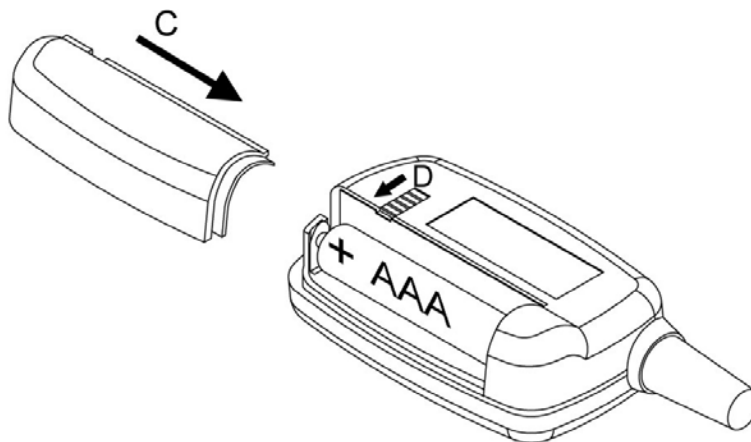

## 2. Installation of the Front (1) and Rear (2) Sensors

Each sensor is designed specifically for the front and rear tires; you have to make sure they are installed in their specified positions. When inserting the batteries into the sensors, do not mix up the Front (1) and Rear (2) sensor caps. Each sensor is marked on its cap and within its body indicating its position on the motorcycle.

### Insert Batteries in Sensors

Battery Installation for Tire Pressure Sensor:

- A. Remove sensor cap by rotating counter-clockwise.



- B. When inserting lithium battery make sure battery polarity is correct.

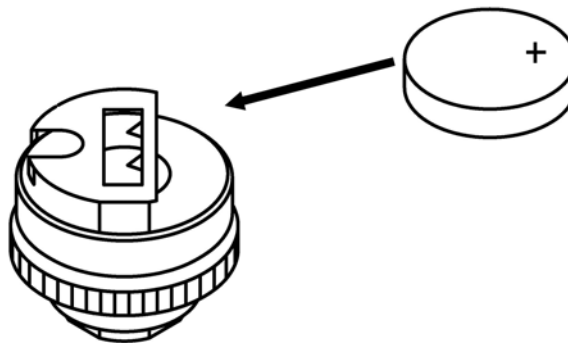

Immediately the LCD Receiver/Monitor will receive signals from the corresponding sensors and report the pressure value on the screen. At first you will find the value shows “00.0”. It is because the sensors have not been mounted yet.

*Note: After removing the battery, you will need to let the system reset. Please allow it to sit for 10 seconds before inserting the battery again.*

- A. Install sensor cap by rotating clockwise.



Please ensure the sensors are in the correct (Front (1) or Rear (2)) position. Do not mix up sensor caps. Both sensor cap and sensor body have reference marks indicating position.

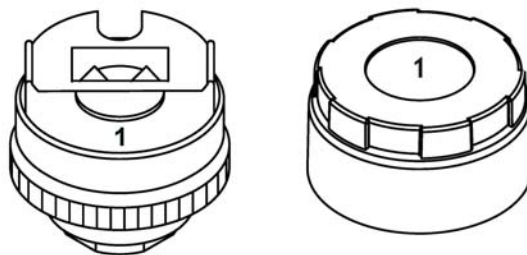

*Front (1) for example*

*Please verify clearance when used with a 90 degree valve stem (Softail, etc) to clear any and all calipers or other components before use.*



**Anti –Theft Ring for Sensors: (installation is optional)**

*Anti –Theft Ring is designed to prevent the possibility of sensors being easily stolen.*

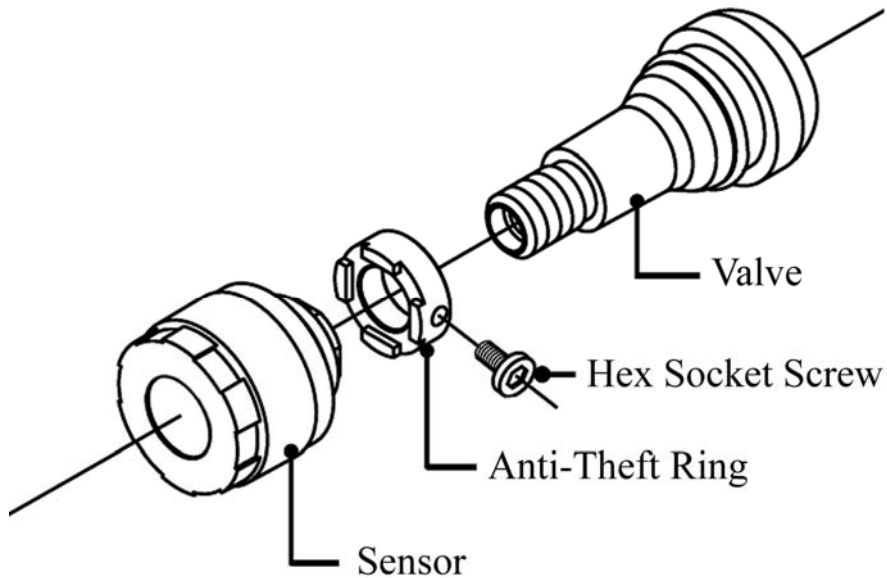

- A. Place the Anti-Theft Ring onto the valve stem.
- B. Install sensor onto valve stem. Do not over tighten the sensor as it may become damaged.
- C. Adjust the Anti-Theft Ring position to seat it with the sensor firmly in place.
- D. Insert the hex socket screw into the Anti-Theft Ring.  
(Do not exert excessive pressure as damage to the valve may occur.)
- E. When the Front (1) and Rear (2) tire pressure sensors are installed, check for air leaks using detergent water. (Spread detergent water on the valve stem and watch for bubbles.) If the tire pressure sensors and tire valves are properly fitted, no air will be leaking from the system.

# OPERATING INSTRUCTIONS

## 1. LCD Receiver/Monitor Basic Functions

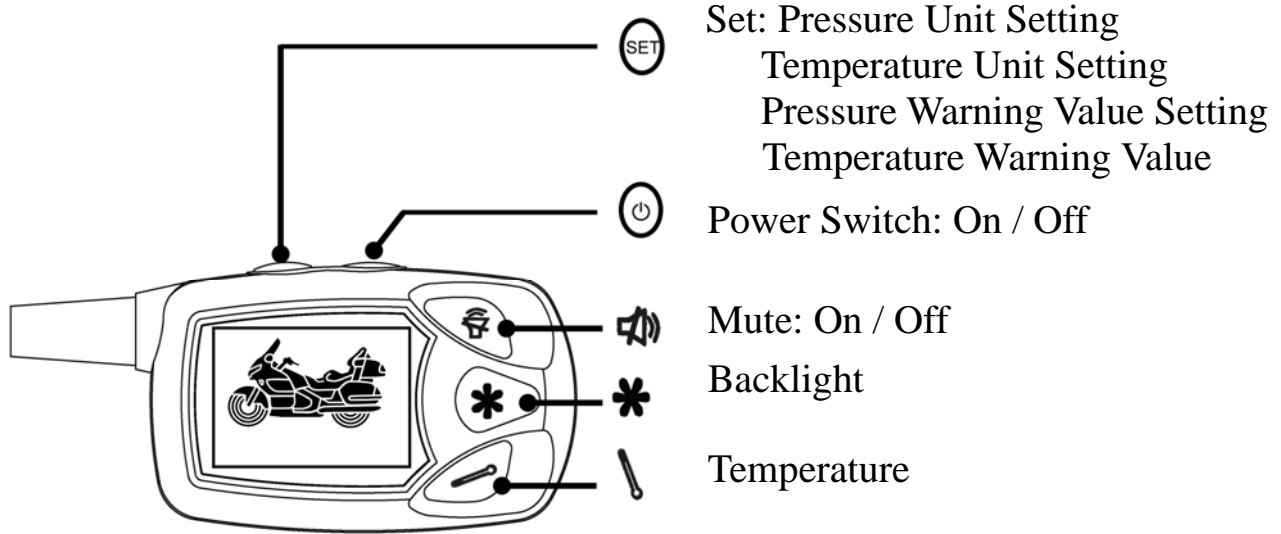



## 2. Advanced Setting Mode

- Press **SET** for 3 seconds to enter advanced setting mode.

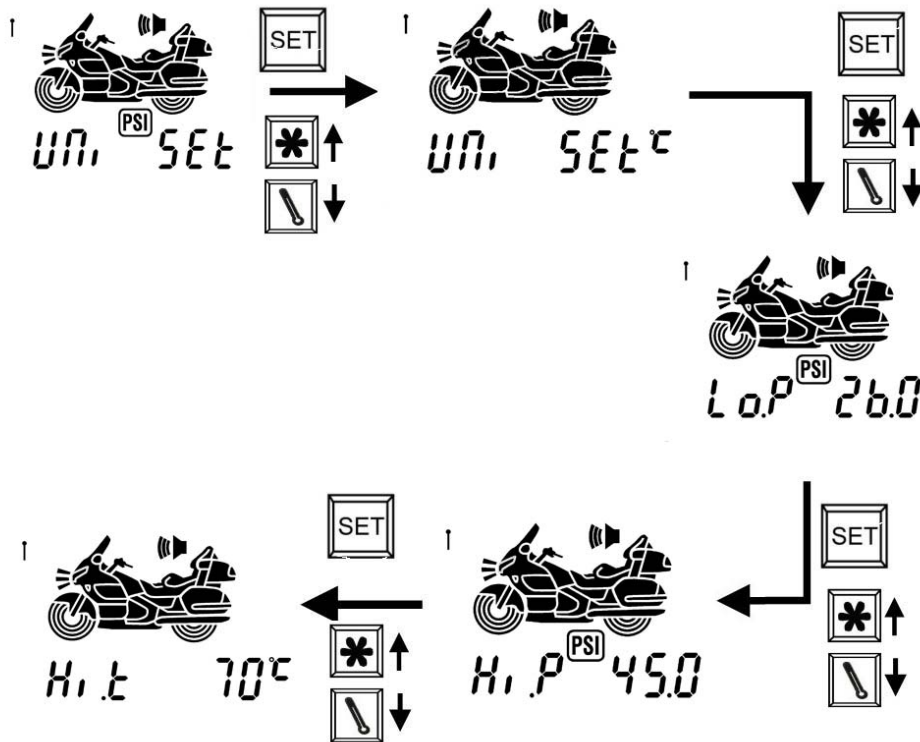
Make your choices by pressing **Temp** and **\*** these will adjust values up or down.



- A. Set tire pressure measuring: Four types of pressure measuring units are available; PSI, KPA, BAR and kg/cm<sup>2</sup>. Users can make their own choices by pressing the thermometer button  and the star button .
- B. Set tire temperature measuring: Adjust setting by pressing the thermometer button and star button for adjusting up or down. Celsius and Fahrenheit are provided.
- C. Setting low tire pressure: Adjust setting by pressing the thermometer button and star button for adjusting up or down. The default value is 26 PSI.
- D. Setting high tire pressure: Adjust setting pressing the thermometer button and star button for adjusting up or down. The default value is 45 PSI.
- E. Setting tire upper temperature warning value: Adjust setting pressing the thermometer button and star button for adjusting up or down.

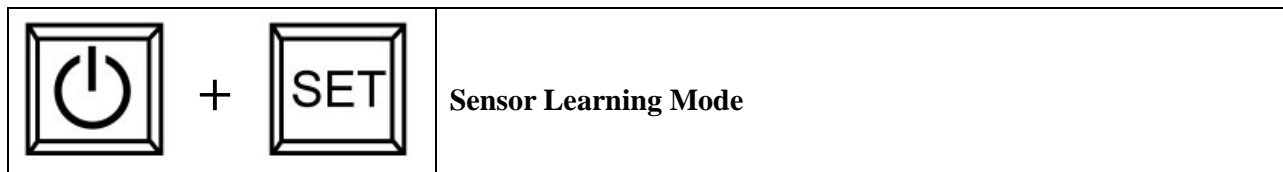

In the unlikelyhood the sensor is broken or missing, the sensor learning mode provides a low cost alternative to replace damaged or lost sensors. These ‘learnable sensors’ are available separately. The LCD receiver/monitor can reload new sensors and the system will integrate this sensor information into its system and will overwrite the replaced sensors information. Pressing the power switch and the SET button at the same time for 3 seconds will activate the systems ‘learning mode’ and TireGard™ will start to recognize new sensors.



Enter learning mode, insert battery into 'learnable sensor' immediately the LCD monitor will beep once and finish learning process.



Take Front Tire (1) for example

The 'learning mode' will continue for about 30 seconds and then back to main screen.

## OPERATING PROCEDURES

### 1. Initialization

Switch on LCD Receiver/monitor to boot up, LCD Receiver/monitor will be communicating with sensors and showing the last tire pressure values before system was turned off.

### 2. Main Screen

After booting up, TireGard™ will enter main screen mode. Most of the time your system will stay in this mode and respond with the latest figures for both tire pressure and temperature. In this mode, you will find the antenna icon will be flashing.

### 3. Automatic Power Off

- A. After power on, if there is no signal from the sensors for 20 minutes the system will power off.
- B. The system will power off if no signal is received for more than one hour after the last signal update.
- C. LCD Receiver/monitor data update will only occur if sensor on tire experiences a 1 PSI pressure change.

### 4. Abnormal Status Alerts

*The LCD receiver/monitor will beep and vibrate once in 10 seconds and repeat 5 times when:*

- A. Tire pressure is below low warning value.
- B. Tire pressure is higher than upper warning value.
- C. Tire temperature higher than upper warning value.

*The LCD receiver/monitor will show low battery icon when:*

- D. LCD receiver/monitor runs out of power.
- E. Tire pressure sensor runs out of power.

## BATTERY INFORMATION

Under normal conditions, sensor batteries will last approximately 1-2 years. LCD Receiver/Monitor will last approximately 6 months. (Service life may be shorter, depending on the conditions of use.) When the battery becomes weak, the low battery indicator will appear on the screen. Replace the battery with a new CR1632 lithium battery for the sensor or with AAA 1.5V battery for the LCD receiver/monitor.

## Definition of Warnings

Item	Status	Purpose	Pattern
1.	Power on LCD monitor	To remind rider power is on	Beeps once
2.	Tire pressure is below lower warning range	The warning of low tire pressure	Beeps for 3 times, vibrating and backlights on. Repeat for 5 times.
3.	When tire pressure is below lower warning range, each 1 PSI down, warnings will be given.	The warning of tire pressure getting lower	Beeps for 3 times, vibrating and backlights on. Repeat for 5 times.
4.	Tire pressure is higher than upper warning range	The warning of high tire pressure	Beeps for 3 times, vibrating and backlights on. Repeat for 5 times.
5.	When tire pressure is higher than upper warning range, each 1 PSI up, warnings will be given.	The warning of tire pressure getting high	Beeps for 3 times, vibrating and backlights on. Repeat for 5 times.
6.	Tire temperature is higher than upper warning value	The warning of high tire temperature	Beeps for 3 times, vibrating and backlights on. Repeat for 5 times.
7.	When tire temperature is higher than upper warning range, each 1 PSI up, warnings will be given.	The warning of tire temperature getting high	Beeps for 3 times, vibrating and backlights on. Repeat for 5 times.
8.	Learnable sensor is integrated	Finish learning mode	Beeps once

## TROUBLESHOOTING

The following checklist will help you remedy problems you may encounter with your unit. Before going through the checklist below, check the connection and operating procedures.



1. Indications disappear from or do not appear in the display
  - a. Make sure power switch is on.
  - b. Make sure monitor has AAA battery properly installed observing correct polarity.
  - c. Use fresh batteries if necessary.
2. No connection between sensors and monitor and you find all tire pressure values are gone (indicated by 3 dashes '---'.)
  - a. Make sure sensor has CR1632 battery properly installed observing correct polarity.
  - b. Use fresh batteries if necessary.
3. Monitor display is getting dark.
  - a. When temperature is over 80°Celsius, it is natural that LCD screen will get dark. When temperature is back to normal, LCD screen will revert back to its normal appearance.

b. When the temperature is below -20°Celsius, the response time of LCD screen will be slower.

4. 'Learning mode' can only accept 'learnable sensors,' not standard sensor.

### 13-315 - PACKAGE CONTENTS

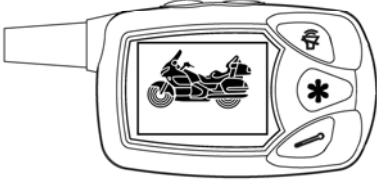
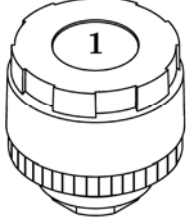
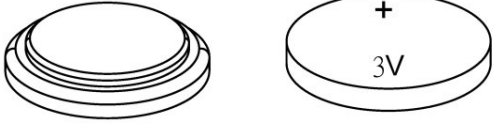
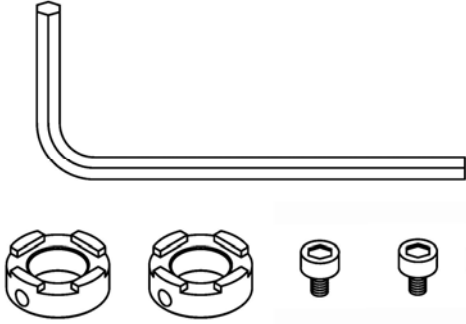
Here are items in whole package.

Item	Photo	Number	
LCD Receiver/Monitor		1 piece	
Tire Pressure Sensor		2 pieces	
CR1632 Battery		2 pieces	
Anti-Theft Ring		Hex head socket wrench	1 piece
		Anti-theft ring	2 pieces
		Hex head socket screw	2 pieces
User Guide		1 piece	
1.5V AAA Battery		1 piece	

## PRODUCT SPECIFICATIONS

### *Tire Pressure Sensor Specifications*

Frequency	433.92MHz
Tire pressure range	0 ~ 60PSI
Accuracy	Tire pressure $\pm 1$ PSI / Tire temperature $\pm 2^{\circ}\text{C}$
Operating voltage	3V DC
Operating temperature	$-40^{\circ}\text{C} \sim 125^{\circ}\text{C}$
Battery life	1~2 years (Approximately)
Dimensions	Diameter 20.5mm x Height 20mm
Weight	10g $\pm$ 1g

### *LCD Receiver/Monitor Specifications*

Frequency	433.92MHz
Operating voltage	1.5V DC
Battery life	6 months (Approximately)
Operating temperature	$-20^{\circ}\text{C} \sim 80^{\circ}\text{C}$
Dimensions	Length 58mm x Width 36mm x Height 19mm
Weight	43g

## WARRANTY

Big Bike Parts® warrants its Show Chrome Accessories® merchandise shall be free from defective material and workmanship under normal use and service for a period of one year from date of purchase. This warranty does not apply to any merchandise that has been modified or becomes defective as a result of improper use or mistreatment of the merchandise. This warranty is in lieu of any other expressed or implied warranty on the part of Big Bike Parts® or anyone else. Big Bike Parts® shall not be liable for any consequential or incidental damage arising out of the breach of any warranties of its merchandise.

