

Copyright © 2018 by Big Bike Parts, Inc. No part of this instruction sheet may be reproduced without the written permission of Big Bike Parts, Inc.

PART NO. 52-942

ELECTRONIC FUSE BLOCK

FITMENT: HONDA GOLDWING/GOLDWING TOUR 2018-NEWER

8/1/2019

TOOLS NEEDED:	PHILLIPS SCREWDRIVER	SMALL FLAT SCREWDRIVER	WIRE CUTTER/CRIMPER	PLIERS	HEAT GUN
	6MM ALLEN WRENCH	ELECTRICAL TAPE (SEE FIG. 9)			

**PLEASE READ THROUGH AND UNDERSTAND THESE INSTRUCTIONS BEFORE BEGINNING.**

**ESTIMATED INSTALLATION TIME: 30 TO 45 MIN.**

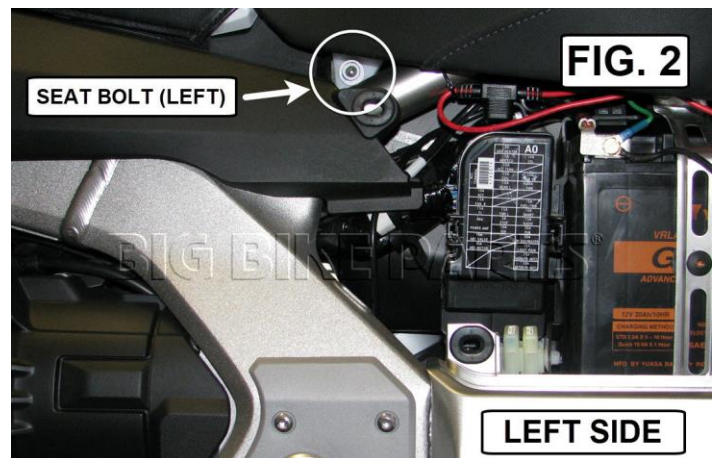
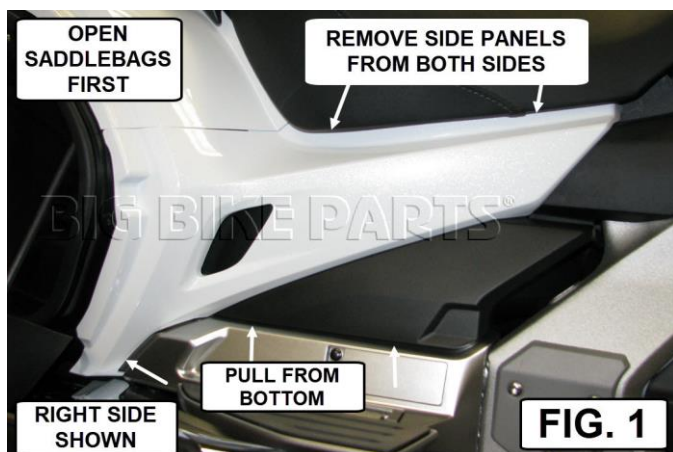
**DO NOT EXCEED 20 AMPS TOTAL WHEN ADDING ACCESSORIES.**

**INSTALLATION:**

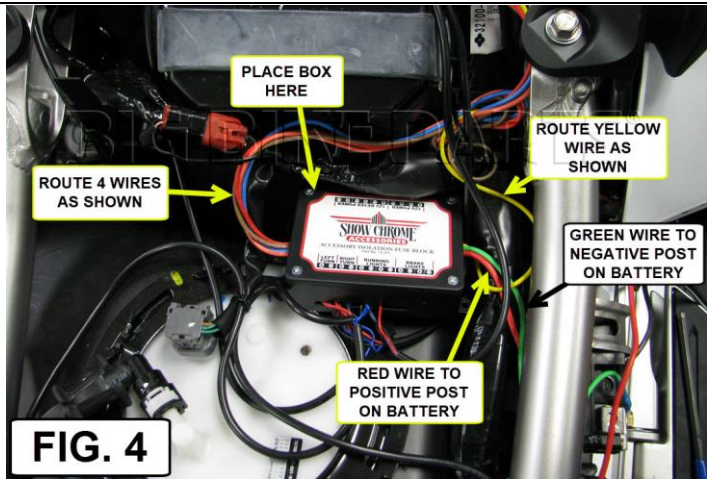
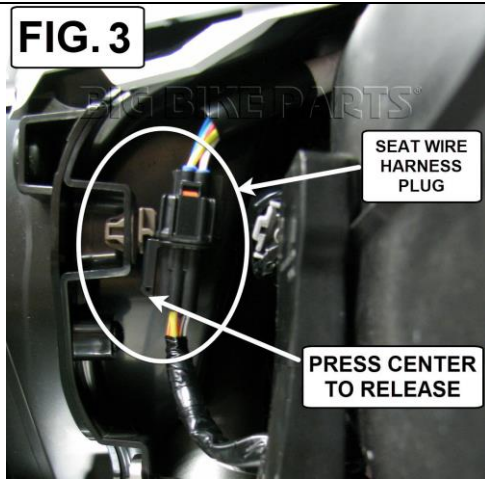
1. OPEN BOTH SADDLEBAGS AND REMOVE THE SIDE COVER FROM EACH SIDE OF THE BIKE (FIG. 1).
2. USE A 6MM ALLEN WRENCH TO REMOVE THE TWO SEAT BOLTS (FIG. 2 SHOWS LEFT SIDE). UNPLUG THE SEAT HARNESS CONNECTOR ON THE RIGHT SIDE OF THE BIKE (FIG. 3) AND REMOVE THE SEAT BY LIFTING THE FRONT AND PULLING FORWARD TOWARDS THE FRONT OF THE BIKE.
3. DISCONNECT BOTH THE POSITIVE AND NEGATIVE CABLES FROM THE BATTERY.
4. PLACE THE ISOLATOR BOX IN THE AREA SHOWN IN FIG. 4.
5. ON THE SIDE OF THE ISOLATOR BOX WITH 3 WIRES, ROUTE THE RED AND THE GREEN WIRES UNDER THE FRAME AND TO THE TOP OF THE BATTERY.
6. ROUTE THE YELLOW WIRE FROM THE ISOLATOR BOX TOWARD THE REAR OF THE BIKE INSIDE THE FRAME AS SHOWN IN FIG. 4.
7. ROUTE THE 4 WIRES FROM THE OTHER SIDE OF THE ISOLATOR BOX TOWARD THE BACK OF THE BIKE AS SHOWN IN FIG. 4. USE SUPPLIED WIRE TIES AS NEEDED TO SECURE THE WIRES.
8. LOCATE THE LEFT AND RIGHT SADDLEBAG CONNECTORS (FIG. 5) AND DISCONNECT BOTH LEFT AND RIGHT SADDLEBAG CONNECTORS.
9. USE FIG. 6 TO DETERMINE LEFT AND RIGHT ACCESSORY SUB-HARNESS PLUGS.
10. INSERT THE LEFT CONNECTOR FROM THE ACCESSORY SUB-HARNESS TO THE LEFT SADDLEBAG CONNECTORS AS SHOWN IN FIG. 7.
11. INSERT THE RIGHT CONNECTOR FROM THE ACCESSORY SUB-HARNESS TO THE RIGHT SADDLEBAG CONNECTORS AS SHOWN IN FIG. 7.
12. TUCK THE CONNECTORS AND WIRES DOWN AND OUT OF THE WAY SO THEY DO NOT GET PINCHED OR PULLED WHEN SEAT IS INSTALLED (FIG. 7). **USE SUPPLIED WIRE TIES TO SECURE WIRES AS NEEDED.**
13. USE THE BLUE WIRE SPLICES SUPPLIED TO CONNECT THE FOUR WIRES FROM THE LEFT SIDE OF THE FUSE BLOCK (SEE FIG.8) TO THE ACCESSORY SUB-HARNESS. MATCH THE CORRESPONDING COLORED WIRES FROM THE ISOLATOR BOX TO THE SUB-HARNESS. THEN CONNECT THE YELLOW WIRE FROM THE RIGHT SIDE TO THE YELLOW WIRE ON THE SUB-HARNESS. **NOTE: TRIM WIRES FROM THE ISOLATOR BOX TO DESIRED LENGTH BEFORE ADDING SPLICES. DO NOT CUT WIRES FROM ACCESSORY SUB-HARNESS OR REMOVE CAPS ON THE ENDS OF THE WIRES.**
14. CUT THE RED WIRE FROM THE ISOLATOR BOX ROUTED TO THE BATTERY TO THE DESIRED LENGTH AND STRIP THE END. **(BE SURE WIRE IS LEFT LONG ENOUGH TO REACH POSITIVE BATTERY TERMINAL).**
15. CRIMP ONE OF THE SUPPLIED RING TERMINALS ON THE RED WIRE FROM THE ISOLATOR BOX.
16. REATTACH THE BIKES POSITIVE CABLE AND INCLUDE THE RED WIRE FROM THE ISOLATOR BOX.
17. CUT THE GREEN WIRE FROM THE ISOLATOR BOX TO THE DESIRED LENGTH AND STRIP THE END. **(BE SURE WIRE IS LEFT LONG ENOUGH TO REACH NEGATIVE BATTERY TERMINAL).**
18. CRIMP A RING TERMINAL ON THE END OF THE GREEN WIRE FROM THE ISOLATOR BOX.
19. REATTACH THE NEGATIVE CABLE ON THE BIKE AND INCLUDE THE GREEN WIRE FROM THE ISOLATOR BOX.
20. REASSEMBLE BIKE IN REVERSE ORDER.

**INSTALLING ACCESSORIES:**

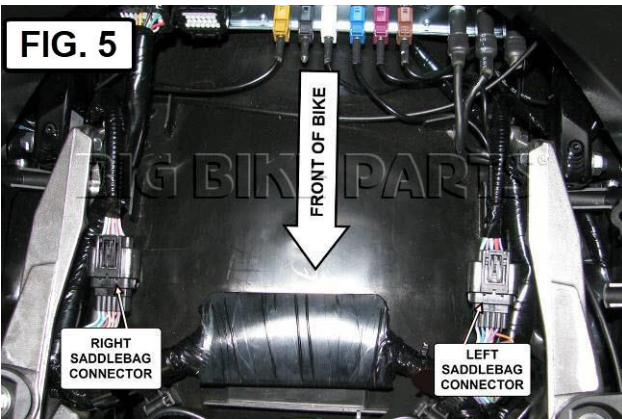
18. USING A PHILLIPS SCREW DRIVER REMOVE THE FOUR SCREWS AND COVER FROM THE ISOLATOR BOX.
19. USING FIG. 8 AS A GUIDE TO LEARN WHAT EACH TERMINAL CONNECTOR IS TO BE USED FOR WHEN ATTACHING ACCESSORIES. **NOTE: THE ISOLATOR BOX COVER ALSO HAS A DIAGRAM FOR THE TERMINAL BLOCKS.**
20. CONNECT THE POSITIVE WIRES FROM YOUR ACCESSORIES TO THE TERMINALS MARKED (+) IN THE LOCATION YOU WANT.
21. CONNECT THE NEGATIVE WIRE TO ANY OF THE TERMINALS MARKED (-) AS THESE ARE ALL COMMON.
22. IF INSTALLING OR PLANNING ON MULTIPLE ACCESSORIES USE METHOD SHOWN IN FIG. 9 FOR A CLEAN AND SAFE INSTALLATION.
23. REPLACE COVER AND FOUR SCREWS.



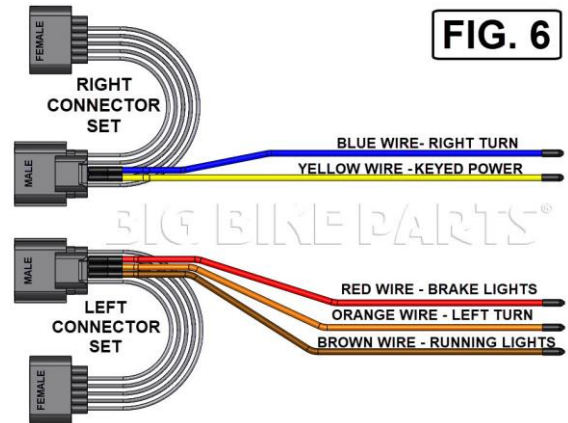
**FIG. 3**



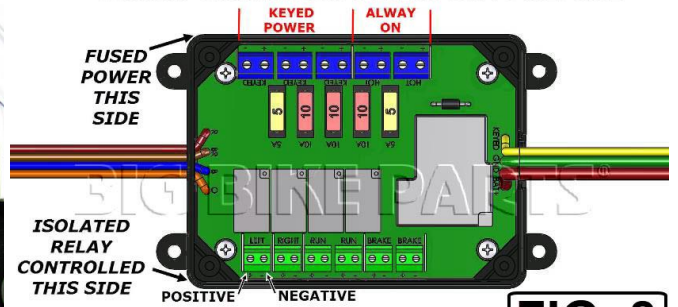
**FIG. 5**



**FIG. 6**

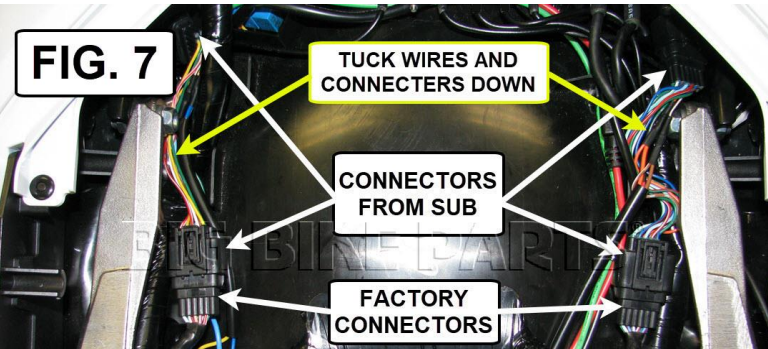


"CONNECT CHARGERS AND POWER PORT TO THIS SIDE"

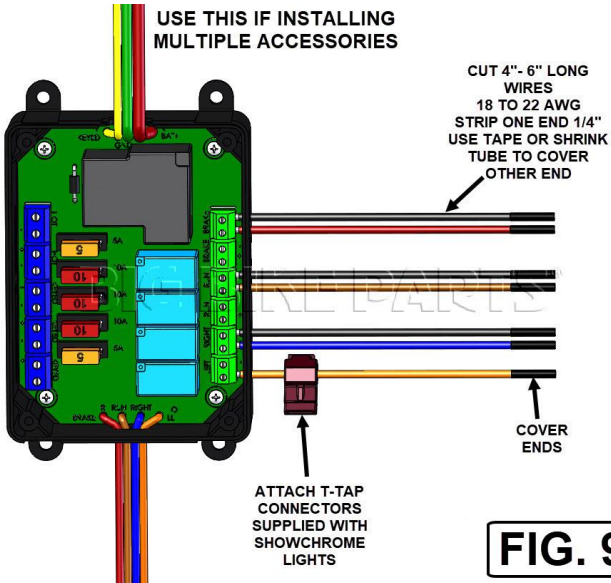


**FIG. 8**

**FIG. 7**



USE THIS IF INSTALLING MULTIPLE ACCESSORIES



**FIG. 9**

**NOTICE**

IGNORING THE CONTENTS OF THESE INSTRUCTIONS MAY AFFECT THE PRODUCT PERFORMANCE AND FUNCTIONALITY. NOT FOLLOWING THESE INSTRUCTION MAY CAUSE DAMAGE TO THE PRODUCT OR THE VEHICLE TO WHICH IT IS BEING ATTACHED.